

Installation advices - Instructions for the use



TOUCH CONTROL  
VITROCERAMIC COOKING HOBS

100% ELBA QUALITY  
MADE IN ITALY



**ELBA**  
TALENT FOR COOKING



Made in Italy



## **Dear Customer,**

*Thank you for having purchased and given your preference to our product.*

*The safety precautions and recommendations reported below are for your own safety and that of others. They will also provide a means by which to make full use of the features offered by your appliance.*

*Please preserve this booklet carefully. It may be useful in future, either to yourself or to others in the event that doubts should arise relating to its operation.*

***This appliance must be used only for the task it has explicitly been designed for, that is for cooking foodstuffs. Any other form of usage is to be considered as inappropriate and therefore dangerous.***

***The manufacturer declines all responsibility in the event of damage caused by improper, incorrect or illogical use of the appliance.***

### **DECLARATION OF CE CONFORMITY**

- This appliance has been designed to be used only for cooking. Any other use (such as heating a room) is improper and dangerous.
- This appliance has been designed, constructed, and marketed in compliance with:
  - Safety requirements of the “Low voltage” Directive 2014/35/EU;
  - Safety requirements of the “EMC” Directive 2014/30/EU;
  - Requirements of EU Directive 93/68/EEC;
  - Requirements of EU Directive 2011/65/EU.



### **IMPORTANT INFORMATION FOR CORRECT DISPOSAL OF THE PRODUCT IN ACCORDANCE WITH EC DIRECTIVE 2012/19/EC.**

At the end of its working life, the product must not be disposed of as urban waste. It must be taken to a special local authority differentiated waste collection centre or to a dealer providing this service.

Disposing of a household appliance separately avoids possible negative consequences for the environment and health deriving from inappropriate disposal and enables the constituent materials to be recovered to obtain significant savings in energy and resources. As a reminder of the need to dispose of household appliances separately, the product is marked with a crossed-out wheeled dustbin.



## IMPORTANT SAFETY PRECAUTIONS AND RECOMMENDATIONS

**IMPORTANT: This appliance is designed and manufactured solely for the cooking of domestic (household) food and is not suitable for any non domestic application and therefore should not be used in a commercial environment.**

**The appliance guarantee will be void if the appliance is used within a non domestic environment i.e. a semi commercial, commercial or communal environment.**

**Read the instructions carefully before installing and using the appliance.**

- This appliance has been designed and manufactured in compliance with the applicable standards for the household cooking products and it fulfills all the safety requirements shown in this manual, including those for surface temperatures. Some people with sensitive skin may have a more pronounced temperature perception with some components although these parts are within the limits allowed by the norms. The complete safety of the appliance also depends on the correct use, we therefore recommend to always pay a extreme attention while using the product, especially in the presence of children.
- After having unpacked the appliance, check to ensure that it is not damaged. In case of doubt, do not use it and consult your supplier or a professionally qualified technician.
- Packing elements (i.e. plastic bags, polystyrene foam, nails, packing straps, etc.) should not be left around within easy reach of children, as these may cause serious injuries.
- Some appliances are supplied with a protective film on steel and aluminium parts. **This film must be removed before using the appliance.**
- **IMPORTANT:** The use of suitable protective clothing/gloves is recommended when handling or cleaning this appliance.
- Do not attempt to modify the technical characteristics of the appliance as this may become dangerous to use. The manufacturer declines all responsibility for any inconvenience resulting from the inobservance of this condition.

- Do not operate your appliance by means of an external timer or separate remote-control system.
- Do not carry out cleaning or maintenance operations on the appliance without having previously disconnected it from the electric power supply.
- Do not use a steam cleaner because the moisture can get into the appliance therefore making it unsafe.
- Do not cover the hob with aluminium foils.
- Do not touch the appliance with wet or damp hands (or feet).
- Do not use the appliance whilst in bare feet.
- If you should decide not to use this appliance any longer (or decide to substitute another model), before disposing of it, it is recommended that it be made inoperative in an appropriate manner in accordance to health and environmental protection regulations, ensuring in particular that all potentially hazardous parts be made harmless, especially in relation to children who could play with unused appliances.
- The various components of the appliance are recyclable. Dispose of them in accordance with the regulations in force in your country. If the appliance is to be scrapped, remove the power cord.
- After use, ensure that the controls are in the off position.
- Children less than 8 years of age shall be kept away unless continuously supervised.
- This appliance can be used by children aged from 8 years and above and persons with reduced physical, sensory or mental capabilities or lack of experience and knowledge if they have been given supervision or instruction concerning use of the appliance in a safe way and understand the hazards involved. Children shall not play with the appliance. Cleaning and user maintenance shall not be made by children without supervision.
- The manufacturer declines all liability for injury to persons or damage to property caused by incorrect or improper use of the appliance.

- **WARNING:** During use the appliance and its accessible parts become hot; they remain hot for some time after use.
  - Care should be taken to avoid touching heating elements on the hob.
  - To avoid burns and scalds, young children should be kept away.
- Make sure that electrical cables connecting other appliances in the proximity of the cooktop cannot come into contact with the hob.
- **WARNING:** Unattended cooking on a hob with fat or oil can be dangerous and may result in fire. **NEVER** try to extinguish a fire with water, but switch off the appliance and then cover flame e.g. with a lid or a fire blanket.
- **WARNING:** Danger of fire: do not store items on the cooking surfaces.
- Do not place or leave empty pans on the glass ceramic hob.
- Do not allow heavy or sharp objects to drop on the glass ceramic hob.
- Do not scratch the hob with sharp objects. Don't use the hob as a work surface.
- **WARNING:** If the hob is cracked or otherwise damaged by falling objects etc., disconnect the appliance from the electrical power supply to avoid the possibility of electric shock and call Customer Service.
- **WARNING:** When correctly installed, your product meets all safety requirements laid down for this type of product category. However special care should be taken around the underneath of the appliance as this area is not designed or intended to be touched and may contain sharp or rough edges, that may cause injury.
- **CAUTION:** The cooking process has to be supervised. A short term cooking process has to be supervised continuously.
- Models provided with power supply cable. If the power supply cable is damaged, it must be replaced only by an authorised service agent in order to avoid a hazard.

- If the appliance is not fitted with a supply cord and a plug, or with other means for disconnection from the supply mains having a contact separation in all poles that provide full disconnection under overvoltage category III conditions, means for disconnection must be incorporated in the fixed wiring in accordance with the wiring rules.
- **WARNING:** The appliance and its accessible parts become hot during use.  
Care should be taken to avoid touching heating elements.  
Children less than 8 years of age shall be kept away unless continuously supervised.
- **WARNING:** Use only hob guards designed by the manufacturer of the cooking appliance or indicated by the manufacturer of the appliance in the instructions for use as suitable or hob guards incorporated in the appliance. The use of inappropriate guards can cause accidents.

## **ENERGY LABELLING/ECODESIGN**

- Commission regulation (EU) No 66/2014 (implementing Directive 2009/125/EC of the European Parliament and of the Council).

Reference to the measurement and calculation methods used to establish compliance with the above requirements:

- Standard EN 60350-2 (hobs: electric cooking zones and/or areas).

## **USE OF THE APPLIANCE, ENERGY SAVING TIPS**

### **HOB**

#### **ELECTRIC COOKING ZONES AND/OR AREAS**

- Avoid pouring liquids on the zones/areas while they are hot.
- Use flat-bottomed (electric hotplate type) pots and pans only.
- Use cooking receptacles which cover as much of the surface of the cooking zone/area as possible.
- To save electricity, use lids whenever possible.
- When the pan comes to the boil, turn the heat down to the level desired. Remember that the cooking zone/area will continue to produce heat for about five minutes after it has been turned off.



# Advice for the installer

# 1 INSTALLATION

## IMPORTANT:

- The appliance is designed and approved for domestic use only and should not be installed in a commercial, semi commercial or communal environment.  
**Your product will not be guaranteed if installed in any of the above environments and could affect any third party or public liability insurances you may have.**
- This appliance is to be installed only by an authorised person according to the current local regulations and in observation of the manufacturer's instructions.  
Failure to comply with this condition will render the guarantee invalid.
- Incorrect installation, for which the manufacturer accepts no responsibility, may cause personal injury of damage.
- This appliance shall only be serviced by authorized personnel.
- Always disconnect the cooktop from mains power supply before carrying out any maintenance operations or repairs.
- **Important: The use of suitable protective clothing/gloves is recommended when handling or installing this appliance.**
- **The appliance must be housed in heat resistant units.**
- **The walls of the units must not be higher than work top and must be capable of resisting temperatures of 70 °C above room temperature.**
- **We would point out that the adhesive which bonds the plastic laminate to the furniture must withstand temperatures not less than 150 °C to avoid delamination.**
- **Do not install the appliance near inflammable materials (eg. curtains).**

## WARNING

**When correctly installed, your product meets all safety requirements laid down for this type of product category.**

**However special care should be taken around the underneath of the appliance as this area is not designed or intended to be touched and may contain sharp or rough edges, that may cause injury.**

## STANDARD INSTALLATION

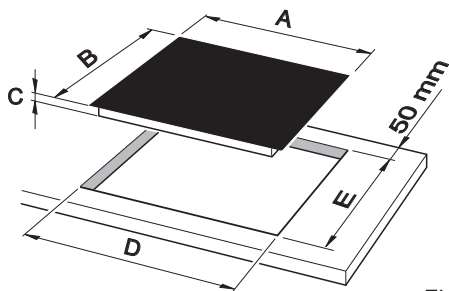

Fig. 1.1a

## FLUSH INSTALLATION (MODELS WITHOUT METAL TRIM/S ONLY)

If you wish to install the hob flush with the work surface, it is necessary to execute/carry out a milling in the hole of the cut-out as indicated in figs. 1.1b.

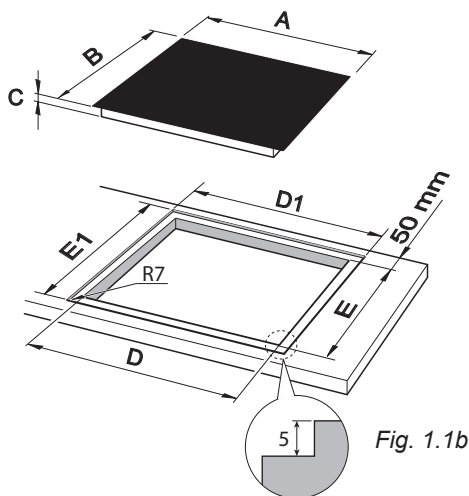

Fig. 1.1b

Description	Measures (mm)						
	A (*)	B (*)	C (**)	D	D1	E	E1
<b>60cm wide models</b>	600	520	44 or 49 for flush installation	560	605	480	525

(\*) For models with metal trim/s add 4mm to the measurement for each trim.  
Example: front metal trim= B+4mm.

(\*\*) from the top of countertop to bottom of cooktop.

## FITTING REQUIREMENTS

This cooktop can be built into a working surface from 20 mm thick and 600 mm deep.

In order to install the ceramic hob into the kitchen fixture, a hole with the dimensions shown in figures 1.1a or 1.1b has to be made, keeping in consideration the following:

- A 20 mm ventilation gap must be provided between the bottom of the appliance and any cabinetry, draw unit or oven (fig. 1.3).
- If the cooktop is installed above an oven, the oven shall be provided with cooling fan. The two appliances should be connected to the electrical supply with independent connections.
- The ceramic hob must be kept no less than 50 mm away from any side wall (from side edge of cutout).
- The rear wall must be at least 50 mm from the ceramic hob (from rear edge of cutout).
- There must be a distance of at least 650 mm between the hob and any wall cupboard or extractor hood positioned immediately above (see fig. 1.2).
- Standard installation (not flush): Do not seal the cooktop into the benchtop with silicone or glue; this makes future servicing difficult. The manufacturer will not cover the costs of removing the cooktop, or of damage caused by this removal.
- **The walls surrounding the cooktop must be made of heat-resistant material.**
- **Do not install the appliance near inflammable materials (eg. curtains).**

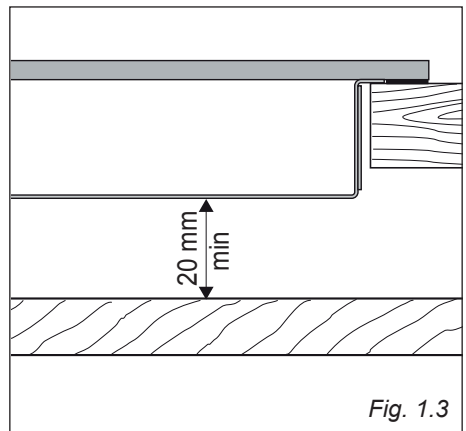
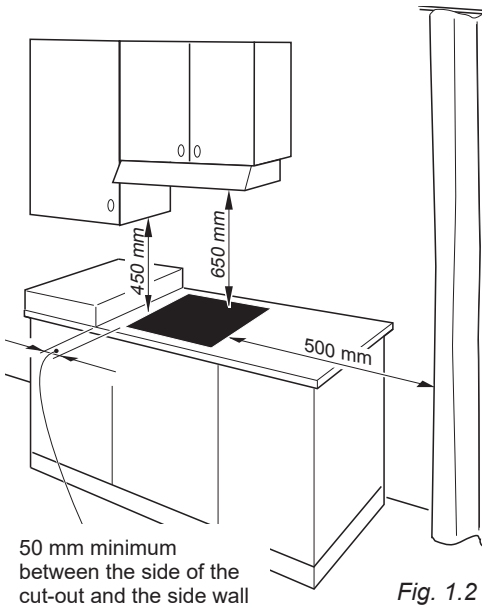

## FASTENING THE COOKTOP

Each cooktop is provided with an installation kit including brackets and screws for fastening the cooktop to benches from 20 mm thick. Before you install the cooktop, make sure that the work surface is square and level, and no structural members interfere with space requirements previously indicated.

The kit includes four metal clips “B” and four self-threading screws “A” (fig. 1.4).

- Cut the unit according to the dimensions in fig. 1.1a or 1.1b.
- Turn the hob upside down and rest the glass side on a soft surface.
- Spread the seal “D” around the edge of the hob (fig. 1.5).
- Fasten the metal clips “B” into the hole “C” using the screws A”. Make sure that the metal clips are mounted correctly as shown in the figure 1.4.
- Put the cooktop into the cutout and position it correctly.
- Using a sharp cutter or trimmer knife, trim the excess sealing material around the edge of the cooktop. Take care not to damage the workbench.
- In case to install the hob flush with the work surface, fill any gaps between the glass and along the perimeter of the work surface with insulating silicone, and wipe away any excess.

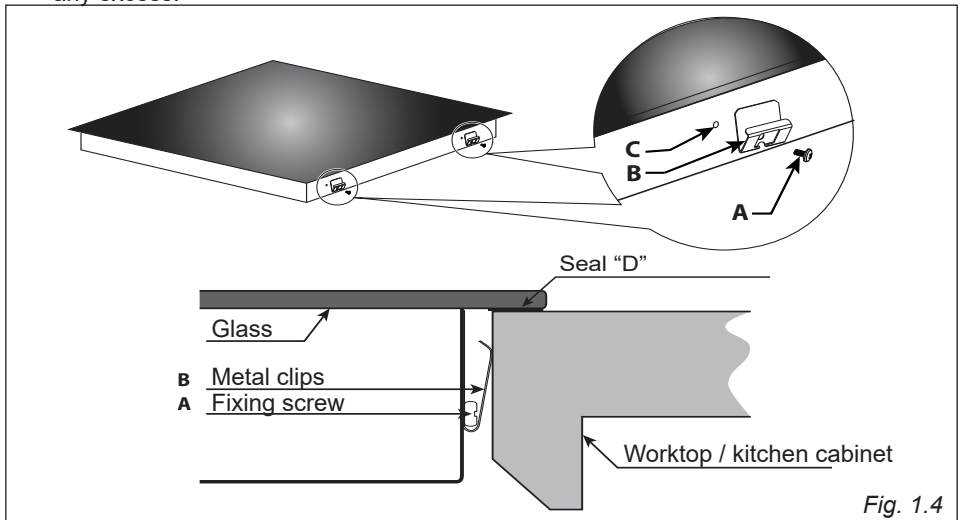

**IMPORTANT:** Spread the sealing material “D” around the edge of the hob (edge of the glass). The sealing material “D” must be installed correctly to guarantee a perfect seal between the appliance and the unit. Incorrect installation may cause irreparable damage to the appliance.

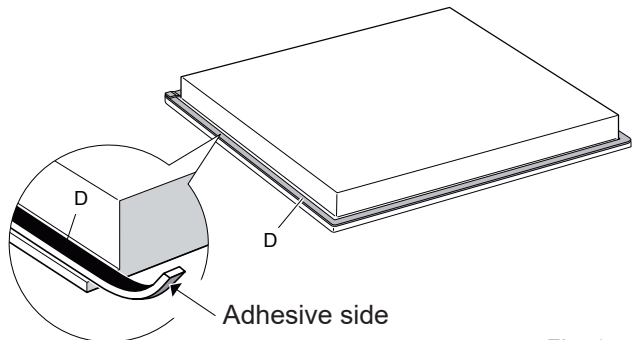

**IMPORTANT:** Installation must be carried out according to the manufacturer's instructions. Incorrect installation may cause harm and damage to people, animals or property, for which the manufacturer accepts no responsibility.

Before carrying out any work on the electrical section of the appliance, it must be disconnected from the mains.

**Connection to a good earth wiring system is absolutely essential.**

The manufacturer accepts no responsibility for any inconvenience caused by failure to comply with this rule.

**If the hob surface is cracked disconnect the appliance from the mains and contact the After-Sales Service.**

## ELECTRICAL REQUIREMENTS

- Connection to the electric power supply must be carried out by a qualified technician and following the appropriate safety regulations.
- The appliance must be connected to the mains checking that the voltage corresponds to the value given in the rating plate and that the electrical cable sections can withstand the load specified on the plate.
- The appliance should be connected directly to the mains placing an omnipolar switch with minimum opening between the contacts of 3 mm between the appliance and the mains (Australia and New Zealand only: means providing full disconnection under overvoltage category III conditions must be incorporated in the fixed wiring in accordance with AS/NZS 3000).
- The power supply cable must not touch the hot parts and must be positioned so that it does not exceed 50°C above ambient.
- Once the appliance has been installed, the switch must always be in a accessible position.

**N.B. For connections to the mains power supply, never use adaptors, reductions or multiple power points as these may overheat and catch fire.**

In the event that installation should require modifications to the mains supply wiring system, it is recommended that a qualified technician be called to carry out substitution.

He should also check that the domestic electrical system is suitable for the power absorbed by the appliance.

## CONNECTION OF THE POWER SUPPLY CABLE

**Important! This cooktop must be connected to the electricity supply only by an authorised person.**

To connect the feeder cable to the hob it is necessary to carry out the following operations:

- Unhook the terminal board cover “A” by inserting a screwdriver into the two hooks “B” (fig. 2.1). Open completely the terminal block cover “A”.
- Unscrew the screw “C”, then unhook the cable clamp “D” by inserting a screwdriver into the hook “E”. Remove completely the cable clamp “D” (fig. 2.1).
- Connect the phase, neutral and earth wires to terminal board “F” according to the diagrams in fig. 2.2; the U bolts “G” (fig. 2.1) shall be used as indicated in the diagrams in fig. 2.2 (they are supplied already fitted to the terminals or inside the terminal board, behind the cover).
- Strain the feeder cable and block it with cable clamp “D” (by hooking hook “E” and screwing screw “C”).
- Close the cover “A” of the terminal board “F” (check the two hooks “B” are correctly hooked).

**NOTE: The earth conductor must be left about 3 cm longer than the others.**

**The operations must be executed by a qualified technician.**

### MODELS SUPPLIED WITH POWER CORD ALREADY FITTED TO THE APPLIANCE

**FEEDER CABLE SECTION “Type H05RR-F, H07RN-F or H05V2V2-F (resistance to temperatures of 90°C)”**

220-240 V ac (V 2 ac)	3 x 2,5 mm <sup>2</sup> (*) (**)	or 3 x 4 mm <sup>2</sup> (*)	or 5 x 1,5 mm <sup>2</sup> (*)
380-415 V 2N ac	5 x 1,5 mm <sup>2</sup> (*) (***) , some models only		
380-415 V 3N ac	5 x 1,5 mm <sup>2</sup> (*) (***) , some models only		

(\*) Connection with wall box connection.

(\*\*) Diversity factor applied. A diversity factor may be applied to the total loading of the appliance only by a suitably qualified person.

(\*\*\*) See also “MODELS SUPPLIED WITH POWER CORD 5x1,5 mm<sup>2</sup> ALREADY FITTED TO THE APPLIANCE”

### MODELS SUPPLIED WITHOUT POWER CORD ALREADY FITTED TO THE APPLIANCE

**FEEDER CABLE SECTION “Type H05RR-F or “H05V2V2-F (resistance to temperatures of 90°C)”**

220-240 V ac (V 2 ac)	3 x 2,5 mm <sup>2</sup> (*) (**)
380-415 V 2N ac	4 x 1,5 mm <sup>2</sup> (*)
380-415 V 3N ac	5 x 1,5 mm <sup>2</sup> (*)

(\*) Connection with wall box connection.

(\*\*) Diversity factor applied. A diversity factor may be applied to the total loading of the appliance only by a suitably qualified person.

Fig. 2.1

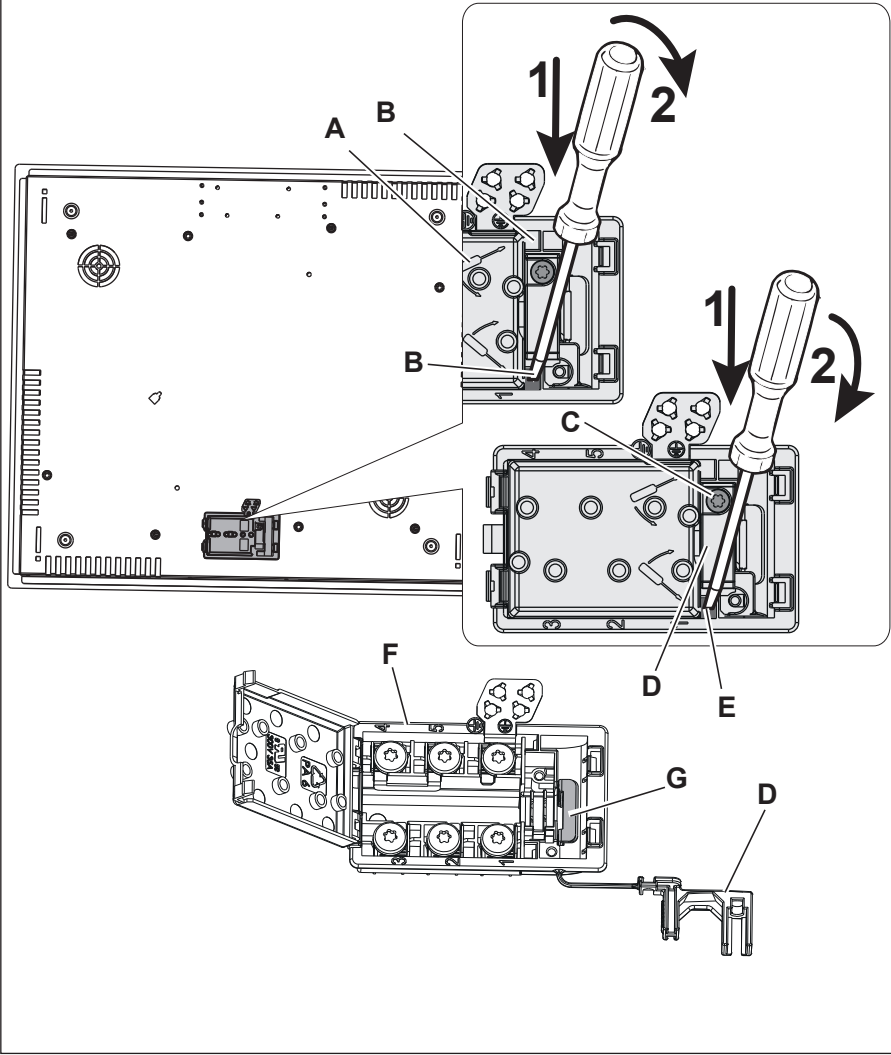
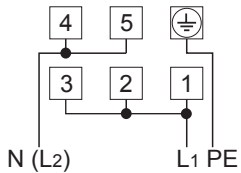
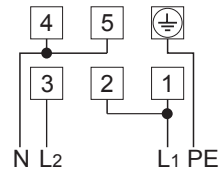

Fig. 2.2

220 - 240 V ac (V 2 ac)



380 - 415 V 2N ac



380 - 415 V 3N ac

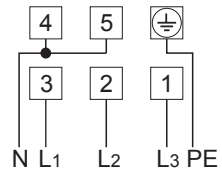



## MODELS SUPPLIED WITH POWER CORD 5x1,5 mm<sup>2</sup> ALREADY FITTED TO THE APPLIANCE

- The cooktop is supplied with a power cord already fitted to the appliance and it is suitable for a single-phase type electrical connection (fig. 2.3).
- For the two-phase type electrical connection (fig. 2.4):
  - separate the black and brown wires by removing the metallic terminal;
  - remove about 5 mm of the insulation sheathing from the terminal end of the black and brown wires;
  - tightly fit a new metallic terminal (1,5 mm) on the terminal end of each wire (black and brown).
- For the three-phase type electrical connection (fig. 2.5):
  - disconnect the blue and gray crimped wires from the terminal block and separate them by removing the metallic terminal on both ends (to access the terminal block see chapter “CONNECTION OF THE POWER SUPPLY CABLE”). Remove about 5 mm of the insulation sheathing from both the terminal ends of the blue and gray wires. Tightly fit a new metallic terminal (1,5 mm) on both the terminal ends of each wire (blue and gray). Connect the blue and gray wires respectively to the N and L3 terminals of the terminal block and close its cover.
  - separate the black and brown wires by removing the metallic terminal. Remove about 5 mm of the insulation sheathing from the terminal ends of the black and brown wires. Tightly fit a new metallic terminal (1,5 mm) on the terminal end of each wire (black and brown).

### **ATTENTION!**

All the operations/electrical connections must be carried out by a qualified technician.

### **CAUTION!**

Do not pierce or weld the terminal ends of the wires. This is strictly forbidden!

### **CAUTION!**

Do not connect the power cord to the electrical power supply without the metallic terminals correctly in place.

**If the supply cord is damaged, it must be replaced by the manufacturer or its service agent or a similarly qualified person in order to avoid a hazard.**

“220-240 V ac (V 2 ac)” connection		“380-415 V 2N ac” connection		“380-415 V 3N ac” connection	
	Green - Yellow		Green - Yellow		Green - Yellow
N	Blue and Gray	N	Blue and Gray	N	Blue
L	Black and Brown	L1	Black	L1	Black
/	/	L2	Brown	L2	Brown
/	/	/	/	L3	Gray

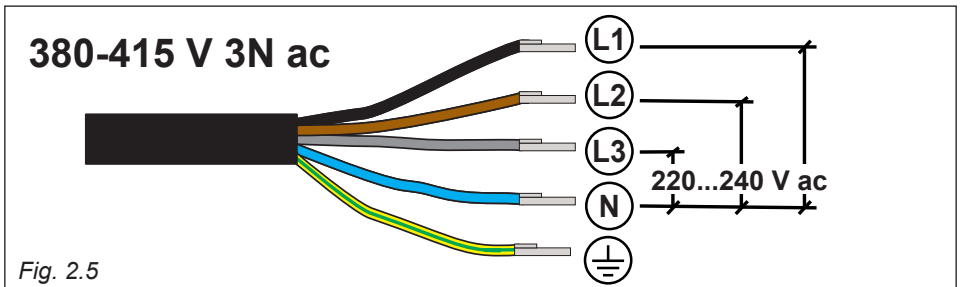
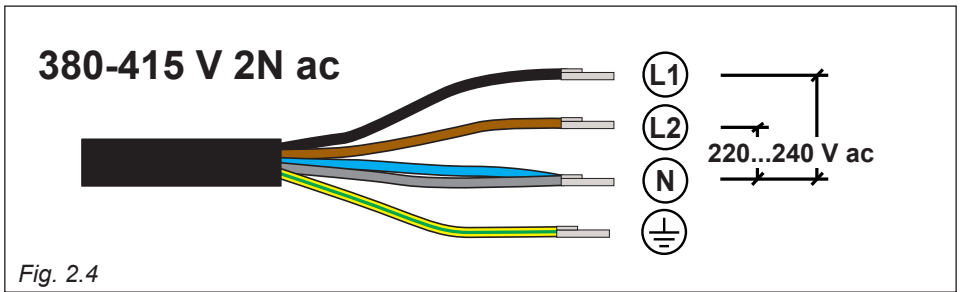
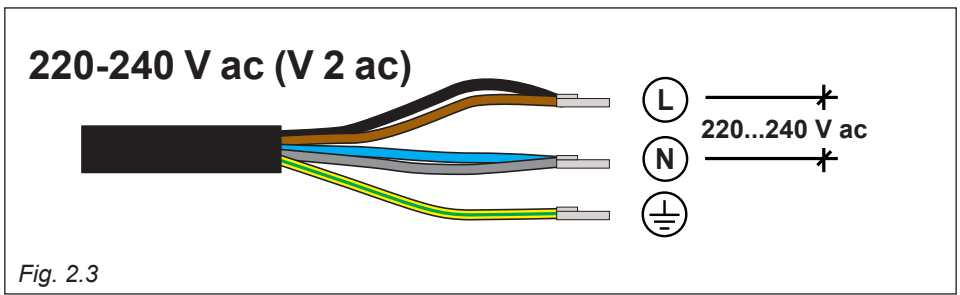

# User guide

# 1

## FEATURES AND TECHNICAL DATA

Fig. 1.1

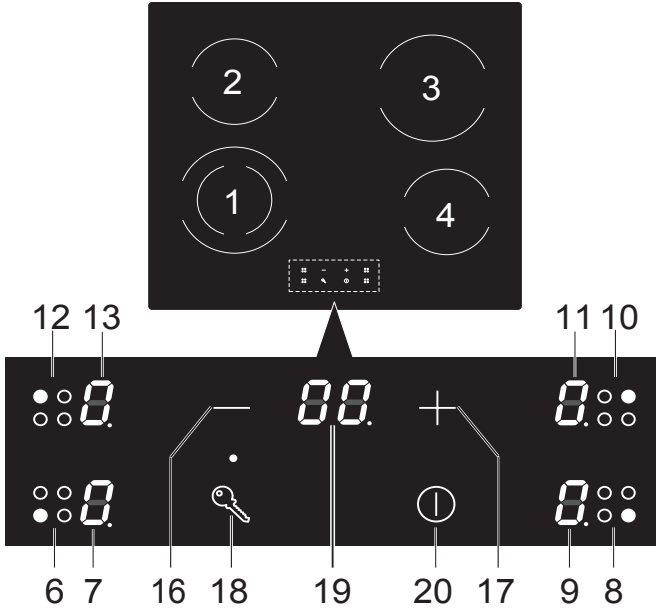
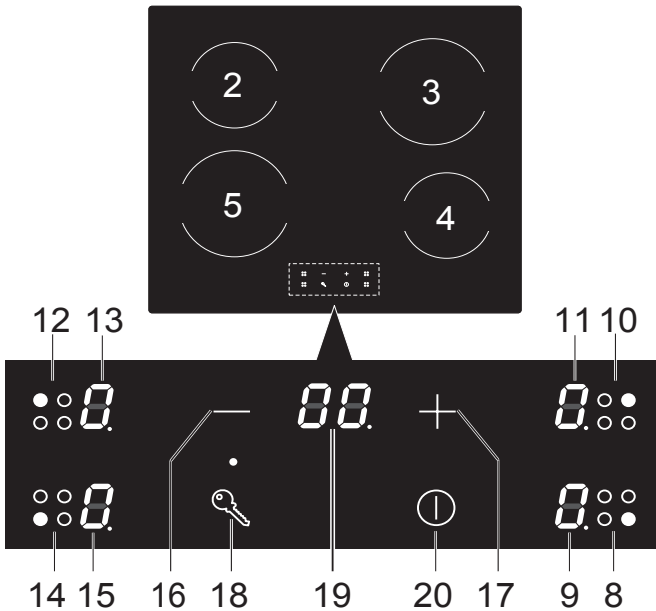

Fig. 1.2



## Electrical insulation Class I

### COOKING ZONES

1. Double hi-light cooking zone    Ø 180/120 mm - 1700/700 W
2. Hi-light cooking zone            Ø 140 mm - 1200 W
3. Hi-light cooking zone            Ø 180 mm - 1800 W
4. Hi-light cooking zone            Ø 140 mm - 1200 W
5. Hi-light cooking zone            Ø 180 mm - 1800 W

### TOUCH-CONTROL DESCRIPTION

6. Front left cooking zone (1) key and ON/OFF outside zone
7. Front left cooking zone (1) display
8. Front right cooking zone (4) key
9. Front right cooking zone (4) display
10. Rear right cooking zone (3) key
11. Rear right cooking zone (3) display
12. Rear left cooking zone (2) key
13. Rear left cooking zone key (2) display
14. Front left cooking zone (5) key
15. Front left cooking zone (5) display
16. Decreasing key of values on operative display (power or timer) \*
17. Increasing key of values on operative display (power or timer) \*
18. Child lock selection key
19. Automatic cooking timer key/display
20. ON/OFF key

\* To access the automatic cooking programming function, press the keys + and - simultaneously with at least one cooking zone set and operating.

## 2 USE OF VITROCERAMIC HOB

The ceramic surface of the hob allows a fast transmission of heat in the vertical direction, from the heating elements underneath the ceramic glass to the pans set on it.

The heat does not spread in a horizontal direction, so that the glass stays "cool" at only a few centimeters from the cooking plate.

The 2 cooking zones are shown by painted disks on the ceramic surface.

Before switching on the cooktop make sure that it is clean.

### IMPORTANT NOTE:

The heating elements incorporate a thermolimiter that switches the element ON/OFF during all settings to protect the ceramic glass from overheating.

The use of incorrect pans and/or wrong pan positioning will cause the temperature limiter to operate more frequently, resulting in a reduction of cooking performance.

The temperature limiter can be seen under the glass dissecting the element.

This is not a fault with the appliance.

### HI-LIGHT RADIANT ZONE (fig. 2.1)

The heating element is formed of a coil of resistant material which reaches the working temperature quickly.

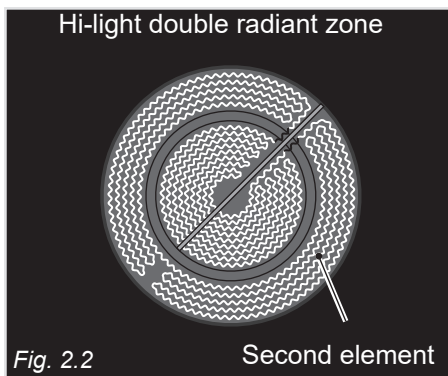
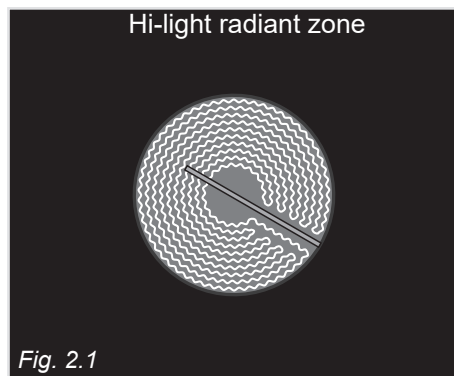

### HI-LIGHT DOUBLE RADIANT ZONE (fig. 2.2)

The heating element is formed of a 2 coils of resistant material which reaches the working temperature quickly (see pag. 28).

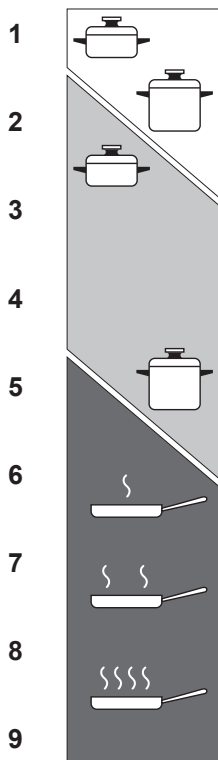

Cooking  
zone  
power  
level



-  Heating
-  Cooking
-  Roasting-frying

## COOKING HINTS:

Power level	Type of cooking
<b>0</b>	Switched OFF
<b>1</b> <b>2</b>	Dishes prepared beforehand For melting operations (butter, chocolate).
<b>3</b>	To maintain food hot and to heat small quantities of liquid.
<b>4</b> <b>5</b>	To heat bigger quantities; to whip creams and sauces. (vegetables, fruits, soups).
<b>5</b> <b>6</b>	Slow boiling, i.e.: boiled meats, spaghetti, soups, continuations of steam cooking of roasts, stews, potatoes.
<b>6</b>	For every kind of frying, cutlets, uncovered cooking, i.e.: risotto..
<b>7</b> <b>8</b>	Browning of meats, roasted potatoes, fried fish, omelettes.
<b>9</b>	Steaks, Potatoes, fried dishes.
<b>P</b>	Rapidly heat up large amount of water.

Fig. 2.3

After a short period of use, experience will teach you which setting is the right one for your needs.

## RESIDUAL HEAT INDICATORS

When the temperature of a cooking plate is over 65°C, the relevant warning “h” (cooktop switched on) or “H” (cooktop switched off) is also lit up to warn of heat on the surface of the hob.

This residual heat will last for a long time after the cooking plate has been switched off.

**During this time you should avoid touching the hob surface over the cooking area.**

**Please pay special attention to ensure that children are not allowed near the hob.**

The “h” (cooktop switched on) or “H” (cooktop switched off) symbol will switch off automatically as soon as the surface temperature of the cooking plate falls below 65 °C.

## COOKING HINTS

- You should use pots and pans with flat bases (pans with the test mark for glassceramic hobs are available from specialist shops).
- The diameter of the pan should match that of the cooking plate (or be slightly bigger) to make the most of the energy.
- Since the cooking surface stays hot for a certain time after the plate has been switched off, you can switch it off 5 or 10 minutes before the end of the cooking. The residual heat of the hob will complete the cooking.
- To save electricity, use pan lids whenever possible.

### **Caution!**

**The cooking hob becomes very hot during operation.  
Keep children well out of reach.**

**Never cook the food directly on the glass ceramic cooktop, but in special pans or containers.**

**WARNING: Hobs become very hot with use, and retain their heat for a long time after cooking has finished (about 30 minutes).  
Children should be supervised at all times and be prevented from touching the hot surfaces, until such time as the appliance has cooled.**



## ADVICE FOR SAFE USE OF THE COOKTOP

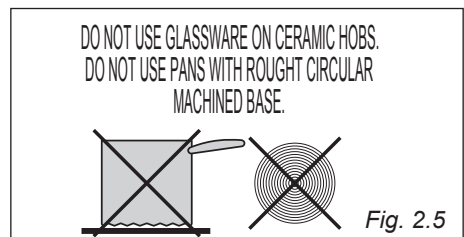
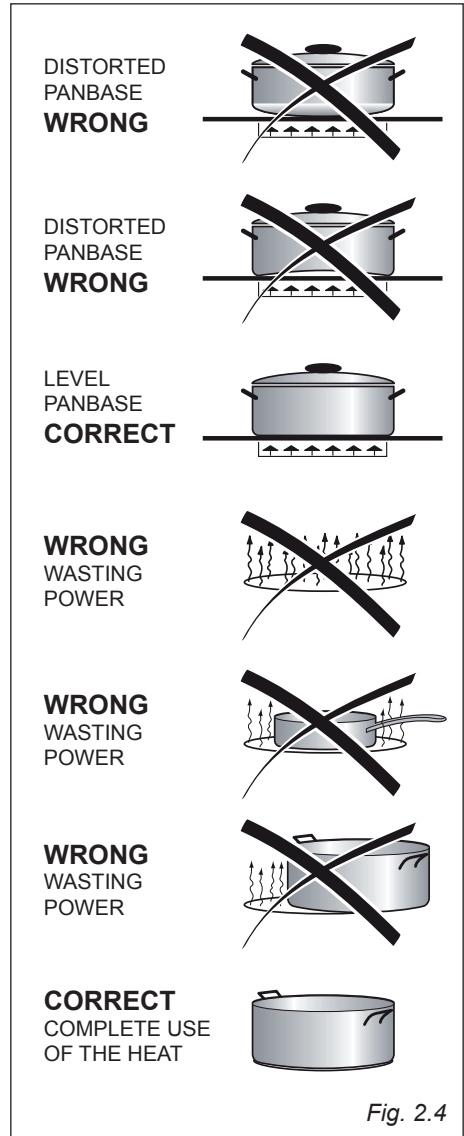

- Before switching on make sure that you have the correct knob for the hotplate chosen. It is advisable to put the pan on the hotplate before switching on and to take it away after switching off.
- Use cookware with flat and even bottoms (be careful when using cast iron vessels). Uneven bottoms can scratch the glass ceramic surfaces
- Always ensure that the base of your saucepan is clean and dry before placing on the hob.
- Do not put aluminium foil or plastic objects on the cooking zones when they are hot.
- Do not leave wet or damp lids on the hob.
- The glass-ceramic surface and pans must be clean. Carefully eliminate any food remains (especially containing sugar), dirt etc. with the aid of a cleansing agent.
- Pan handles should never stand out beyond the kitchen worktop, as there is a great danger of knocking the pan over. **This will also ensure that children cannot reach them.**
- **If you note a crack in the cooktop, switch the appliance off immediately and call the After-Sales Service.**
- Do not lean over the cooking plate when in use.
- Do not lay cooking foil or plastic materials on the ceramic surface when it is hot.
- Remember that the surface remains hot for a long time (about 30 min.) after the cooking plate has been switched off.
- Follow the cleaning instructions carefully.
- Never use the glass surface for storage.



# 3

## HOW TO USE THE TOUCH CONTROL

### Notes:

- Each selection (by pressing one of the keys) is indicated by an acoustic signal (beep).  
Any time the cooktop is connected to the electrical supply or after a power failure, the safety key-lock protection will be automatically activated (indicator light **ON** above key ).
- Before starting to use the cooktop deactivate the key-lock protection by pressing the key .  
This operation is necessary for the keyboard calibration, to adapt the sensibility of the keys (do not use gloves, use a clear finger).
- If an object is positioned on the touch control area, or in the case of spillage of liquids on control keys, the touch control is switched off automatically 10 seconds after having detected the object/liquid.
- When the touch control reaches an ambient temperature above 96°C, one heating element is switched off. This element cannot be used until the temperature falls below 89°C.

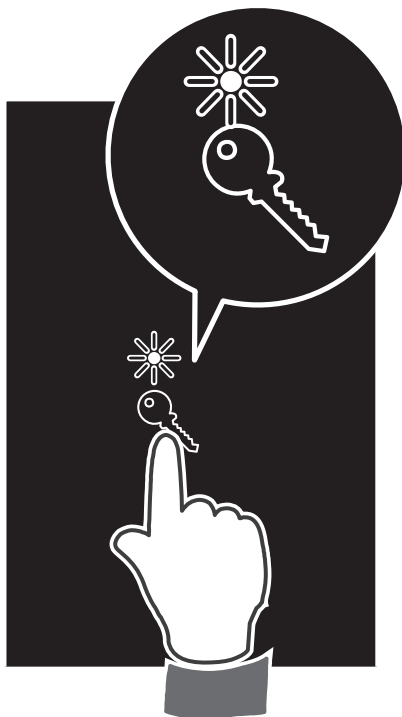

## HOW TO TURN THE TOUCH CONTROL ON AND OFF

### SWITCHING ON

- Press the key ① and keep it pressed until the touch control is lighted.

The displays of the cooking zones read “0”.

#### Notes:

- If the safety key-lock protection is active, the touch control can be turned **ON** only after having deactivated this protection.
- Auto switch-off: If a cooking zone is not turned **ON** within 10 seconds, the touch control will automatically switch off.

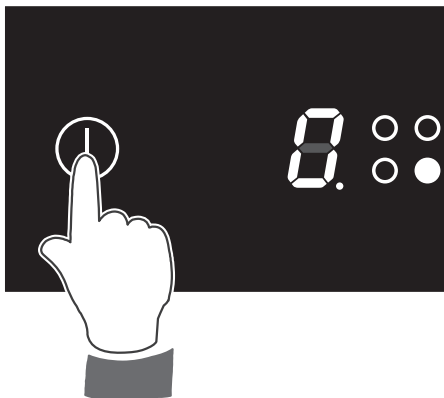

### SWITCHING OFF

The touch control may be switched OFF at any time by pressing the key ①.

If any cooking zones are turned ON, they will be turned OFF

## POWER IGNITION AND ADJUSTMENT OF A COOKING ZONE

To turn ON a cooking zone its touch control must be switched ON (cf. section “HOW TO TURN THE TOUCH CONTROL ON AND OFF”). Press the key to activate the cooking zone to be adjusted.

Press the key + and keep it pressed until the desired power level, ranging between “1” and “9”. By pressing the key + once again, the set power level will change to “P” (maximum level).

As an alternative, press the key —. The choice starts from level “P” (maximum level) down to “1” (minimum level).

To switch Off a cooking zone, press the key — and keep it pressed until the display shows “0”.

With more than one cooking zones operating, select the relative cooking zone before touching the key —.

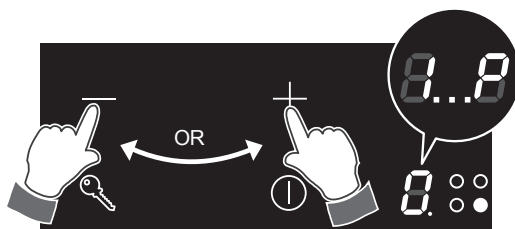





## FUNCTIONING OF THE DOUBLE COOKING ZONE

The double cooking zone consists of two circuits, which may be used in the following modes:

- Reduced cooking zone: only the first heating unit is switched **ON**.
- Extended cooking zone: the first and second heating circuits are both switched **ON**.

Turn on the cooking zone as described in the section: "Power Ignition and Adjustment of a Cooking Zone"; only the first heating unit will switch on.

Press the key  (front left cooking zone display key) to switch on the second circuit (the indicator light above the display lights up to indicate the operation of both zones), then set the desired power level by using the keys  and .

To turn off the second heating circuit press the key  (the indicator light above the display will go out).

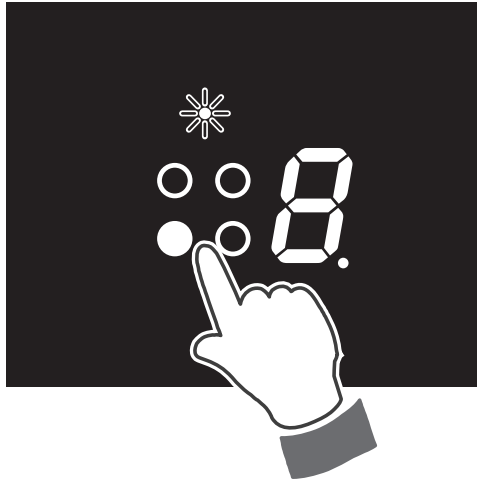

## AFTERHEAT IN COOKING ZONE/S

When switching off a cooking zone (power level "0"), if the temperature of the zone is too warm to be touched the display will show "h".

Avoid touching the hob surface over the cooking area. Please pay special attention to children.

It is still possible to start cooking again; just set the required power level.

Whenever the cooktop is switched off, the residual heat symbol "h" is replaced by "H".

"H" or "h" is turned **OFF** when the cooking zone temperature drops below 65 °C.

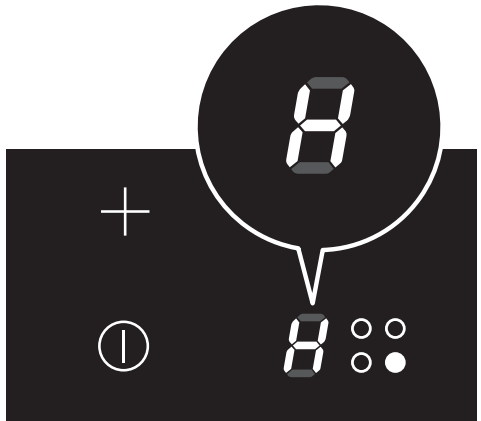

## SAFETY KEY-LOCK TO PROTECT CHILDREN

This function locks the “touch-control” keys against unwanted activation.

To activate the key-lock press the key ; the indicator light above the key symbol will light up.

- Cooking zone/s operating (power level already set): with the key-lock protection active it is only possible to switch off the cooktop.
- Cooktop off: with the key-lock protection active it is not possible to use the cooktop. To use the cooktop deactivate this protection.

To deactivate the key-lock protection just press the key ; the indicator light above the key symbol will go out).



## PROGRAM FOR AUTOMATIC SWITCHING OFF OF A COOKING ZONE

This function permits to set a timer from "01" to "99" minutes for automatic turning Off the cooking zone/s.

With the cooktop switched On:

- Select the cooking zone and set the desired power level.
- Press simultaneously the keys + and -.
- within 5 seconds, press the key + or -:

By pressing the key + the initial value is "00".

By pressing the key - the initial value is "99".

- The time can be changed at any time following the same procedure here above indicated (selecting previously the cooking zone if more than one zone is operating).
- To program another cooking zone, repeat as described above

NOTE: The led indicating the cooking zone closest to the end of the program, is lighted. In the case of one programmed zone only, the led is always lit.

Now the program for automatic switching Off is complete.

At the end of the countdown the cooking zone will switch Off automatically, an acoustic signal (beep) will sound (for 1 minute only), "00" will flash on the timer display and the cooking zone display will show "t" (timer).

Press any button of the touch control to reset the timer.

**Note:** The program for automatic switch Off can be cancelled at any time by resetting the timer to "00".

**IMPORTANT:** Remember to switch Off the zone manually.

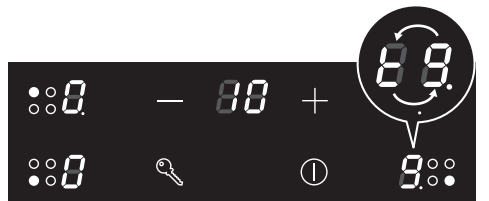
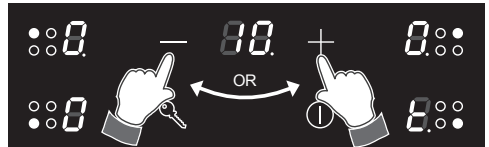
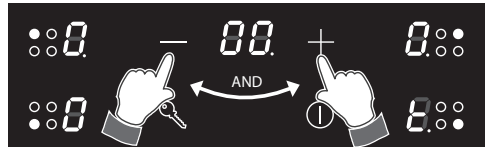

## OPERATION TIME LIMIT OF COOKING ZONES

Each cooking zone is automatically switched **OFF** after a maximum preset time if no operation is performed.

The maximum preset time limit depends on the set power level, as illustrated in this schedule.

Each operation on the cooking hob by using the keys **+** , **-** will reset the maximum operation time at its initial value.

Power level of Cooking zones	Operation time limit
1	10 hours
2	5 hours
3	5 hours
4	4 hours
5	3 hours
6	3 hours
7	2 hours
8	2 hours
9	1 hours
P	1 hours

## ERROR CODE ON THE DISPLAY/S

If an error message appears on the display/s (the display/s show/s “F” and another character alternating - es. “F” e “A”, “F” e “0”, .....):

1. Switch off the cooktop and disconnect it from the mains.
2. Reconnect the cooktop and turn it on. Wait for about two minutes and if the problem does not appear the cooktop can be used.
3. If the problem does not disappear repeat step from 1 to 3.
4. If the problem continues, disconnect the cooktop from the mains and contact your Authorised Service Centre.

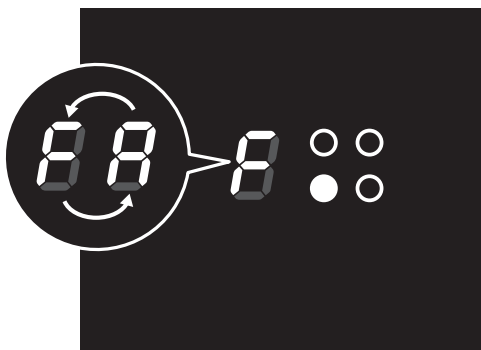

## DISPLAY/S OFF OR NOT CORRECTLY OPERATING

**If a display or the displays are only partially lit or not lit.**



1. Switch off the cooktop and disconnect it from the mains.
2. Reconnect the cooktop and turn it on.
3. Wait for about two minutes and if the problem does not appear the cooktop can be used.
4. If the problem does not disappear repeat step from 1 to 3.
5. If the problem continues, disconnect the cooktop from the mains and contact your Authorised Service Centre.





## MAXIMUM POWER MANAGEMENT

The cooktop maximum power limit (5900 W for model in fig. 1.1 or 6000 W for model in fig. 1.2) can be reduced, by 100 W steps, to a minimum of 2500 W.

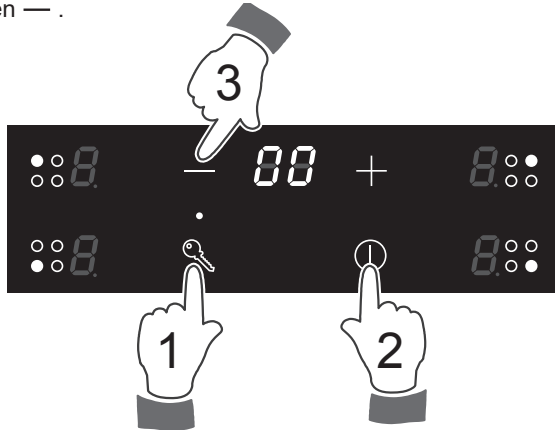

### To change the default total power depending on your requirements:

- Connect the appliance to the electrical power supply.
- Within 30 seconds touch the key  and, keeping it pressed, touch in sequence the key  and then .

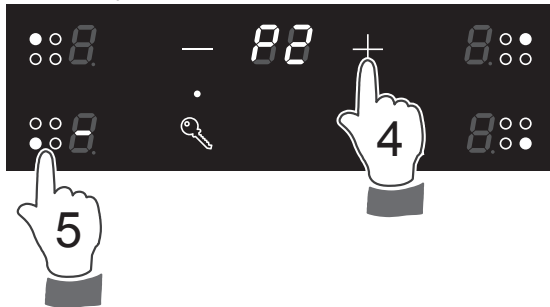

- Touch 2 times the key  until *P2* appears on the display, then touch the front left cooking zone selection key.



- the current set maximum power limit can be read on the displays of the rear cooking zones e.g.:
  - rear left cooking zone= “ 2 ” and rear right cooking zone= “ 5 ” : maximum power limit = 2500 W;
- Touch the keys  or  for selecting a new maximum power limit. Then, to set the new maximum power limit (shown on the displays of the rear cooking zones) press the front left cooking zone. If this is not done within 60 seconds, the system resets automatically and the new power limit is not set.

Selectable maximum power values and higher than the declared maximum power, are to be considered equivalent to the maximum power of the specific model purchased.

## POWER MANAGEMENT WHEN USING THE COOKTOP

When using one or more cooking zones if the total power set on the zones is greater than the maximum power limit, an acoustic signal (beep) sounds and the last set zone shows “  ” for 3 seconds; then the power of that zone is automatically reduced within the allowed limit.

# 4

## CLEANING AND MAINTENANCE

### • **CLEANING THE CERAMIC HOB**

- **Before you begin cleaning, you must ensure that the appliance is switched off and disconnected from the electrical power supply.**
- It is advisable to clean when the appliance is cold.
- Avoid leaving alkaline or acidic substances (lemon juice, vinegar, etc.) on the surfaces.
- Avoid using cleaning products with a chlorine or acidic base.
- **Do not use a steam cleaner because the moisture can get into the appliance thus make it unsafe.**
- **Important: The use of suitable protective clothing/gloves is recommended when handling or cleaning this appliance.**
- **Avoid using a knife or other sharp utensil as these may damage the ceramic surface.**
- Clean surfaces with a damp cloth and use gentle, neutral cleaning products. Dry with a clean, dry cloth.
- **IMPORTANT:** Do not use any abrasive products (e.g. certain types of sponge) and/or aggressive products (e.g. caustic soda, products containing corrosive substances), which could cause irreparable surface damage.

### **WARNING:**

**When correctly installed, your product meets all safety requirements laid down for this type of product category.**

**However special care should be taken around the rear or the underneath of the appliance as these areas are not designed or intended to be touched and may contain sharp or rough edges, that may cause injury.**

## CLEANING THE CERAMIC HOB

- Remove spillages and other types of incrustations.
- Dust or food particles can be removed with a damp cloth.
- If you use a detergent, please make sure that it is not abrasive or scouring. Abrasive or scouring powders can damage the glass surface of the hob.
- All traces of the cleaner must be removed with a damp cloth.
- Dust, fat and liquids from food that has boiled over must be removed as soon as possible. If they are allowed to harden they become increasingly difficult to remove.
- This is especially true in the case of sugar/syrup mixtures which could permanently pit the surface of the hob if left to burn on it.
- Do not put articles on the hob which can melt: i.e plastic, aluminium foil, sugar, sugar syrup mixtures etc.
- If any of these products has melted on the ceramic surface, you should remove it immediately (when the surface is still hot) by using a scraper to avoid any permanent damage to the surface of the hob.
- Avoid using a knife or other sharp utensil as these may damage the ceramic surface.
- Do not use steel wool or an abrasive sponge which could scratch the surface permanently.

## STAINLESS STEEL ELEMENTS (only models with side stainless steel trims)

Stainless steel parts must be rinsed with water and dried with a soft and clean cloth or with a chamois leather.

For persistent dirt, use specific non-abrasive products available commercially or a little hot vinegar.

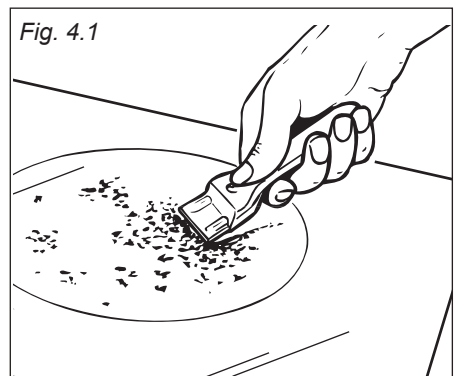

The manufacturer cannot be held responsible for possible inaccuracies due to printing or transcription errors in the present booklet.

The manufacturer reserves the right to make all modifications to its products deemed necessary for manufacturer commercial reasons at any moment and without prior notice, without jeopardising the essential functional and safety characteristics of the appliances.

---

[www.elba-cookers.com](http://www.elba-cookers.com)

**ELBA**

TALENT FOR COOKING

 Made in Italy 